

Payment Application (AMIF, ISF, BMVI)	3
Workflow	4
Create a Payment Application (AMIF, ISF, BMVI).....	4
Record/Edit the Payment Application (AMIF, ISF, BMVI).....	8
General	9
Version Information.....	9
Officials in Charge	10
History.....	12
Documents.....	12
Uploading & Sending Documents	13
Sending an unsent non-integral document	16
Deletion of an unsent document	17
Observations.....	18
Expenditure	19
Declaration & payment application	21
Comments	23
Bank information.....	24
Appendix 1.....	25
Appendix 3.....	27
Appendix 4.....	28
Validate the Payment Application (AMIF, ISF, BMVI).....	29
Prepare Payment Application (AMIF, ISF, BMVI) for send to EC.....	34
Send the Payment Application (AMIF, ISF, BMVI).....	35
Request for Revised Payment Application (AMIF, ISF, BMVI) by MS.....	37
Delete the Payment Application (AMIF, ISF, BMVI)	39
Cancel the Payment Application (AMIF, ISF, BMVI)	41
Create a New Version of the Payment Application (AMIF, ISF, BMVI).....	42
Request to Withdraw the Payment Application (AMIF, ISF, BMVI)	43

Payment Application (AMIF, ISF, BMVI)

PURPOSE

This document describes the actions related to the Payment Application procedure under the CPR Regulation Article 91 and more specific those related to the Payment Applications for AMIF, ISF and BMVI as described in template Annex XXIII of the CPR.

REGULATIONS

More details regarding the regulation of the Payment Applications can be found in the "[About SFC2021](#)" section of the portal.

ROLES

Roles involved in the Payment Application are:

MS Managing Authority (MSMA) Body entrusted with the accounting function (MSAF)	Record Payment Application Upload Payment Application Documents Consult Payment Application Return Payment Application for modification Delete Payment Application Validate Payment Application Prepare Payment Application for send to EC Send Payment Application Request for Revised Payment Application by MS Cancel Payment Application Create New Version of a Payment Application Request to Withdraw Payment Application
MS Audit Authority (MSAA)	Consult Payment Application

FUNDS

AMIF	ISF	BMVI	
------	-----	------	--

Workflow

This section shows the lifecycle to create and manage a Payment Application AMIF/ISF/BMVI.

Click [here](#) to see the Payment Application workflow diagram in high resolution.

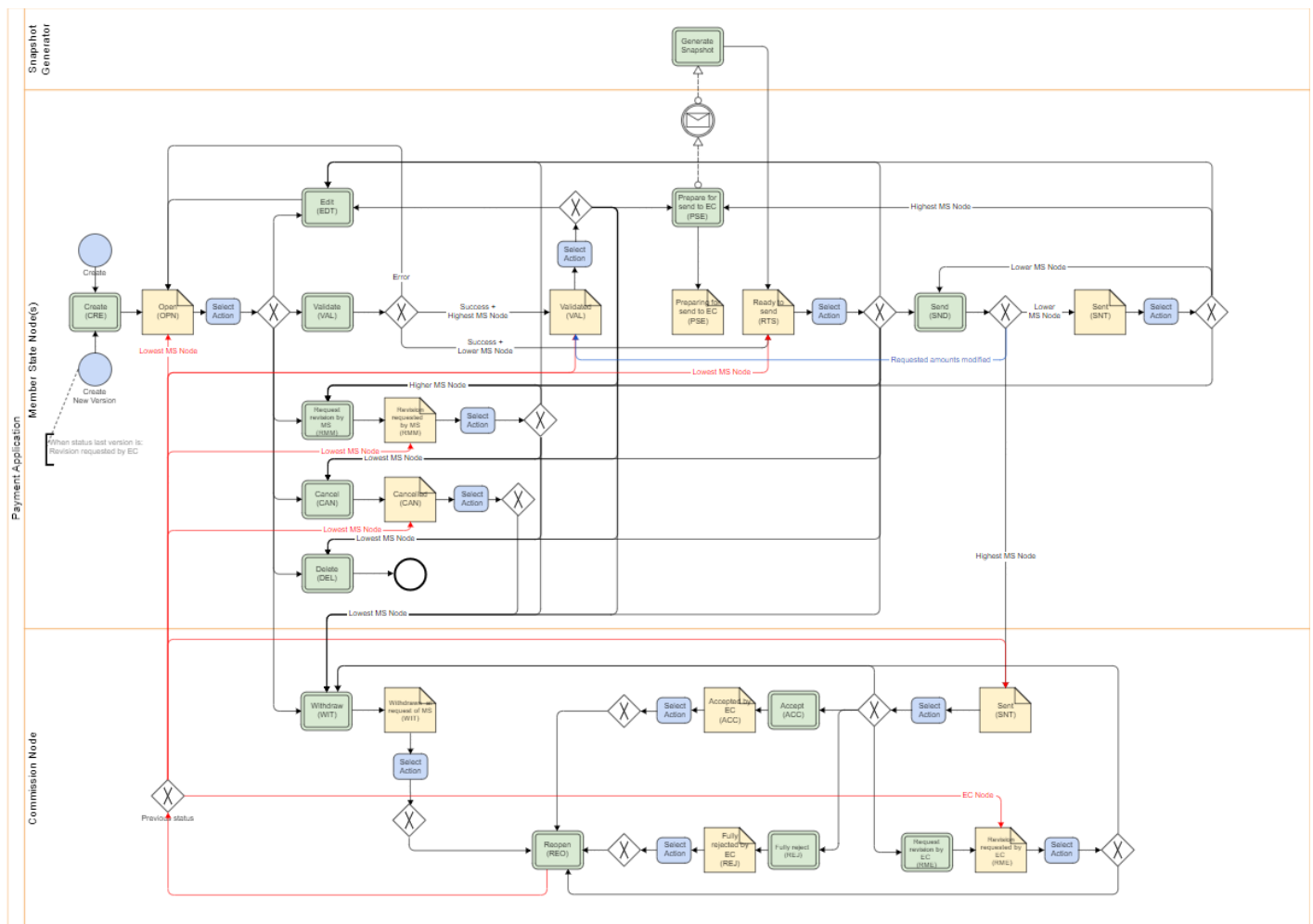

Create a Payment Application (AMIF, ISF, BMVI)

REMARK	<p>The User is an identified User and has the role of MS Managing Authority or Body entrusted with the accounting function with Update rights (MSMAu/MSAFu).</p> <p>When creating a new Payment Application, all existing versions (last working version) from previous Payment Applications for the same CCI and Fund must be SENT to the Commission, CANCELLED, FULLY REJECTED BY EC, ACCEPTED BY EC or WITHDRAWN AT THE REQUEST OF THE MS.</p> <p>For AMIF, ISF and BMVI, maximum 1 Payment Application per Programme, Fund, Accounting Year and Submission Period can be created, FULLY REJECTED BY EC, CANCELLED and WITHDRAWN AT THE REQUEST OF THE MS ones excluded. The following Submission Periods are foreseen in Article 91.1 of the CPR: 1 January - 28 February; 1 March - 31 May; 1 June - 31 July; 1 August - 31 October; 1 - 30 November; and 1 - 31 December. The last payment application submitted by 31 July shall be deemed to be the final payment application for the accounting year that has ended 30 June.</p>
---------------	---

1. To create the Payment Application, go to the **EXECUTION** menu and select the **PAYMENT APPLICATION (AMIF, ISF, BMVI)** option:

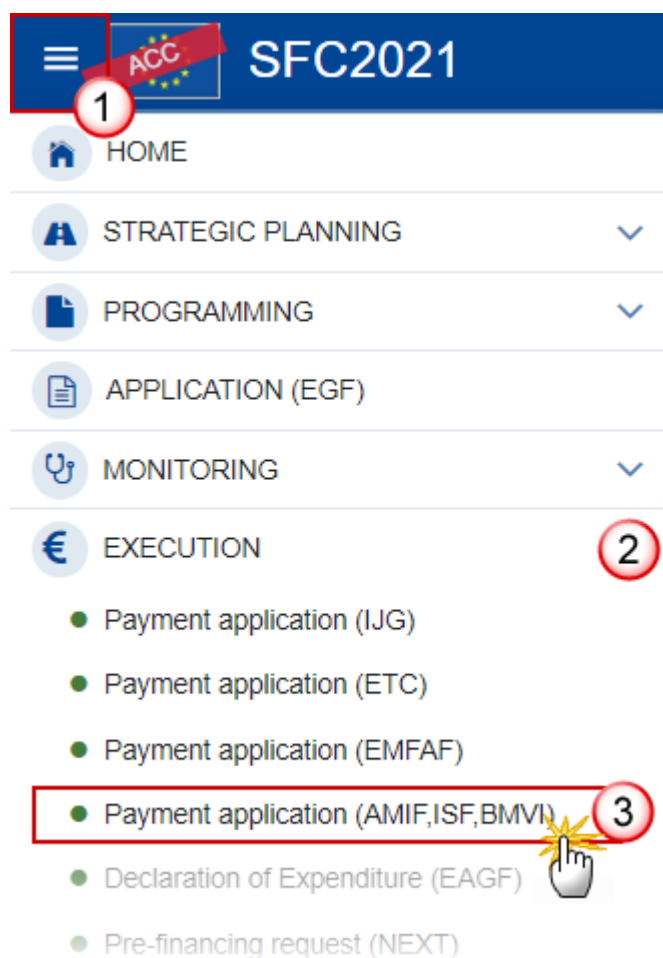

2. In the search screen click on the **CREATE** button to create a new Payment Application:

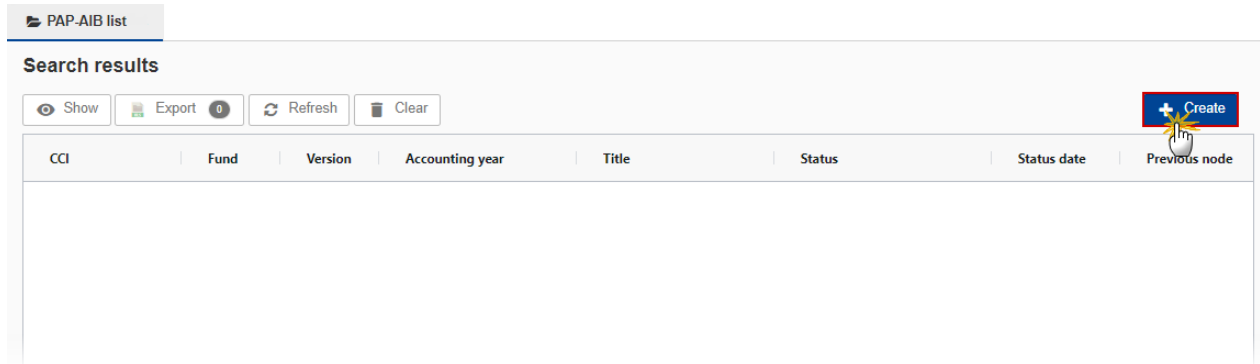

You are redirected to the Payment Application Creation Wizard:

The screenshot shows the 'CREATE PAYMENT APPLICATION' wizard. The title 'CREATE PAYMENT APPLICATION' is displayed in a blue header bar. Below the header, there are four form fields, each with a red border and a red circle containing a number (1, 2, 3, 4) to the right of the field label. The fields are: 'CCI *' with the value '2021ES65AMPR003', 'Fund *' with the value 'AMIF', 'Accounting year *' with the value '01/01/2021 - 30/06/2022', and 'National reference' which is empty. At the bottom of the form, there are two buttons: 'Cancel' and 'Create'. The 'Create' button is highlighted with a red rectangular box and a hand cursor. A red circle containing the number '5' is positioned above the 'Create' button.

3. Enter or select the following information:

(1) Select the *CCI* Number.

The CCI list contains all adopted AMIF/ISF/BMVI Programmes managed at the User's Node, and which contain Funds for which the User is registered. The list returns the CCI, the Programme English Title and the list of Funds covered by the Programme and retrieved from the last adopted version of the Programme.

(2) Select the *Fund*.

A Payment Application is always for one Fund.

(3) Select the *Accounting year*.

A Payment Application is always referring to an Accounting Year as described in Article 91 CPR. The content of the Accounting Year list depends on the date of creation of the Payment Application and on the final due date of the Payment Application for an Accounting Year. The required Accounting Years are those between start and end of eligibility (Accounting Year end date \geq Adopted Programme version start of eligibility and Accounting Year start date \leq Adopted Programme version end of eligibility).

The list of Accounting Years for Payment Applications should therefore contain Accounting Years with Accounting Year start date \leq current date \leq Accounting Year end date + 1 month (Can be created from the start of the Accounting Year until the end of the Accounting Year + 1 month).

It means that between 1/7 and 31/7 the User can create a Payment Application for Accounting Year N-1 and one for Accounting Year N.

(4) Enter the *National reference* if applicable.

(5) Click on **CREATE**.

The status of the Payment Application is **OPEN**.

<p>REMARK</p>	<p>On Create, the system will check that the Fund and Accounting Year combination is valid. Newly added Funds to a Programme after the Accounting Year end date should not be allowed, and not all Accounting Years are required since they depend on the eligibility period of the linked Programme version. When the request is valid, the initial Payment Application structure is created, and a Table of Content (ToC)/Navigation Tree is presented, so the User can continue to populate the structured data of the Payment Application.</p> <p>The Payment Application is linked to the last adopted version of the Programme with a Decision Date smaller or equal to the smallest of current date and Accounting Year End Date and with a start of eligibility date <= Accounting Year end date and with an end of eligibility period >= Accounting Year start date. If such Programme version doesn't exist, an error will be thrown.</p> <p>The records for the Expenditure, the Payment Application, Appendix 1, Appendix 3 and Appendix 4 are automatically created, based on the following information in the linked Programme Version:</p> <ul style="list-style-type: none"> • Table 6 for AMIF/ISF/BMVI Programmes. <p>The first version of a Payment Application for a Fund/Accounting Year has its amounts in Expenditure and Appendix 1, 3 and 4 initialized to null.</p> <p>Consecutive versions of a Payment Application for a Fund/Accounting Year have their amounts in Expenditure and Appendix 1, 3 and 4 copied from the previous Payment Application version of the same Fund/Accounting Year.</p> <p>The Source language is copied from the linked Programme Version.</p> <p>The officials in charge are copied from the previous Payment Application version of the same Programme and Fund, when existing.</p>
----------------------	--

Record/Edit the Payment Application (AMIF, ISF, BMVI)

<p>REMARK</p>	<p>The User is an identified User and has the role of MS Managing Authority or Body entrusted with the accounting function with Update rights (MSMAu/MSAFu).</p> <p>When editing a version of a Payment Application, its status is OPEN, VALIDATED, READY TO SEND or SENT at the level of the Member State or REVISION REQUESTED BY MS and currently resides on the User's Node.</p>
----------------------	--

General

This section includes the header data to identify the main characteristics of the Payment Application.

Version Information

NOTE	<p>The Version Information contains information on the identification and status of the Payment Application Version like the CCI, the Fund, the Version Number, the Accounting Year, the Status, the Node where it currently resides, the Title in English, the National reference and information from the linked Programme like its Commission decision number and date, the Eligibility period and the Programme version number.</p> <p>The Version information for the Payment Application cannot be modified once the version has been created, only the National reference and the Source language can be updated.</p>
-------------	---

1. Click on the **EDIT** button to enter a *National reference* or change the *Source language*:

The screenshot shows the 'Version information' interface. At the top right, there is an 'Edit' button with a pencil icon, highlighted by a red box and a hand cursor. Below the header, there is a table with the following data:

CCI	Fund	Version	Accounting year	Last modified	Current node	
2021ES65AMPR003	AMIF	1.0	01/01/2021 - 30/06/2022	17/06/2022, 14:45	Comunidad Foral de Navarra	

Below the table, there are several sections with labels and values:

- Title in English: **prg home amif isabel**
- Commission decision number: **C(2021)7587**
- Commission decision date: **28/10/2021**
- Eligible from: **01/01/2021**
- Eligible until: **30/06/2022**
- National reference: (empty)
- Programme version: **1.0**

The Edit details pop-up window appears:

Version information ⓘ

Commission decision number C(2021)7587	Commission decision date 28/10/2021
Eligible from 01/01/2021	Eligible until 30/06/2022
National reference <input type="text"/>	Programme version 1.0
Source language * <input type="text" value="Spanish"/>	



Cancel **Save**

2. Enter or change the following information:

- (1) Enter the *National reference* if applicable.
- (2) Change the *Source language* if needed.
- (3) Click on **SAVE** to save the information.

Officials in Charge

NOTE	<p>Officials in Charge can be updated at any time, independent from the status of the Payment Application.</p> <p>Commission Officials (email domain "ec.europa.eu") can only be created/updated/deleted by Commission Users.</p> <p>The officials in charge are copied from the previous Payment Application version of the same Programme and Fund, when existing.</p>
-------------	--

- Click on the **ADD** button  to add a new official in charge.
- Clicking on the **EDIT** icon  of a row will allow you to modify the information of this official.

- Clicking on the **DELETE** icon  of a row will allow you to delete the official in charge selected.

1. Click on the **ADD** button to add a new Official in Charge:

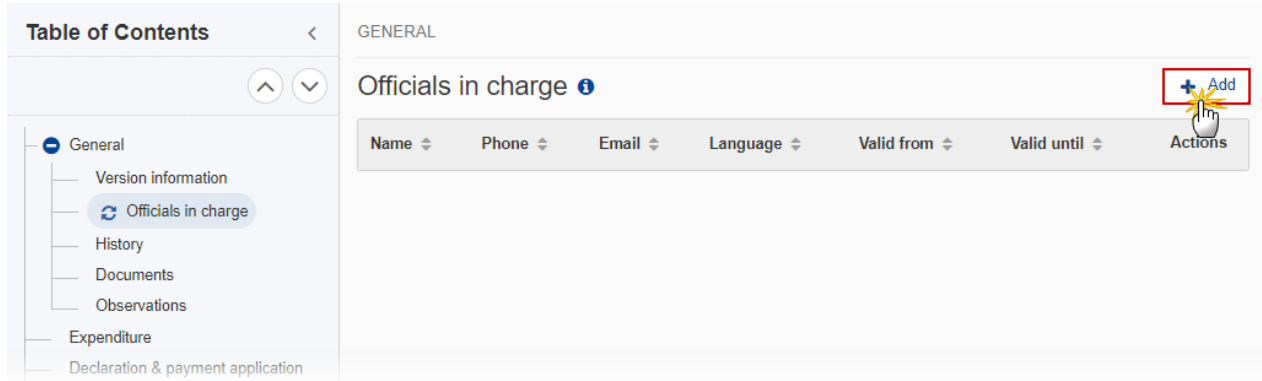

The Edit details pop-up window appears:

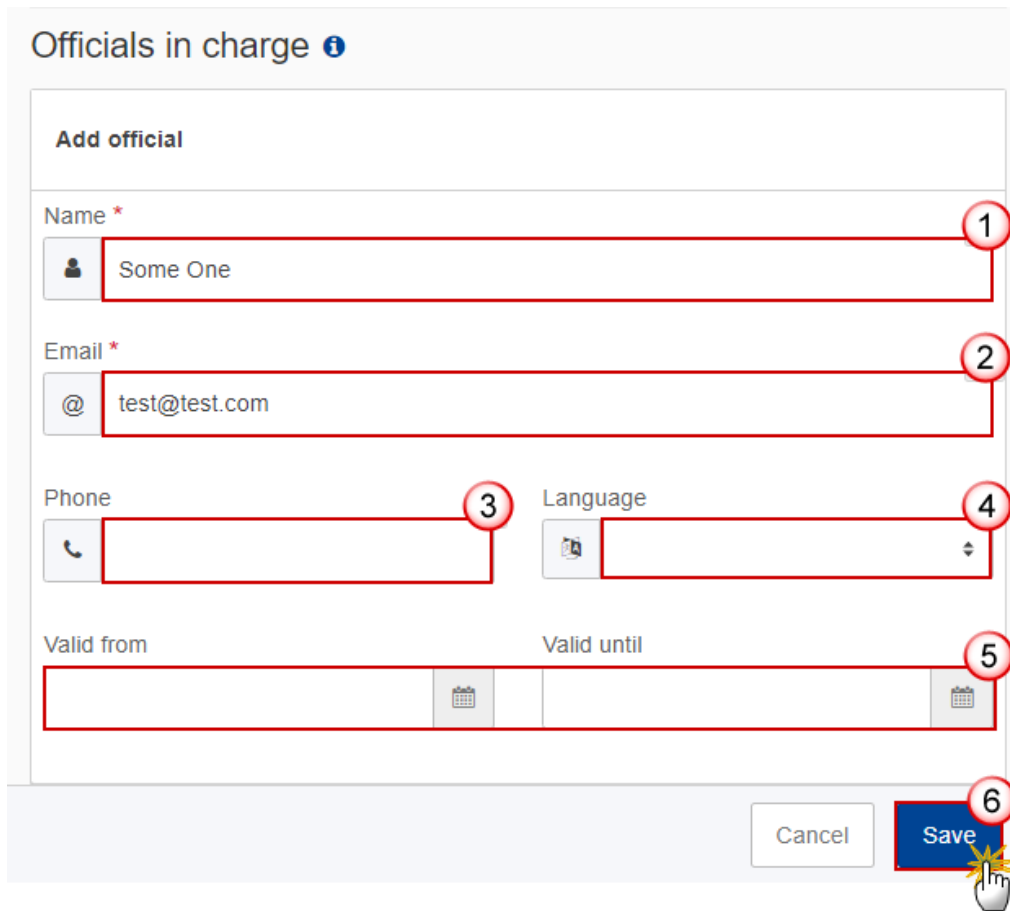

Officials in charge ⓘ

Add official

Name * 1

Email * 2

Phone 3 Language 4

Valid from 5 Valid until 5

Cancel **Save** 6

2. Enter or select the following information:

(1) Enter the *Name*.

(2) Enter the *Email*.

The format of the Email address will be validated by the system and should be unique.

(3) Enter the *Phone* number.

(4) Select the *Language*.

(5) Enter the *Valid from* and *Valid until* dates.

The *Valid until* date should be greater than the *Valid from* date.

(6) Click on **SAVE** to save the information.

History

This section shows all the actions that have been taken on the Payment Application since it was created, for example:

The screenshot displays a user interface with a 'Table of Contents' on the left and a 'History' section on the right. The 'Table of Contents' includes a search bar and a list of menu items: General, Version information, Officials in charge, History (highlighted), Documents, Observations, Expenditure, Declaration & payment application, and Comments. The 'History' section is titled 'GENERAL' and 'History'. It shows a vertical timeline with two entries:

- 17/06/2022 14:54**: Action **Edit** on node **Comunidad Foral de Navarra (ES22)** by **Gsb, Ste (n0001843)**. Includes an **OPEN** button.
- 17/06/2022 14:45**: Action **Create** on node **Comunidad Foral de Navarra (ES22)** by **Gsb, Ste (n0001843)**. Includes an **OPEN** button.

Documents

NOTE	<p>The Documents list shows all documents uploaded against this version of the Payment Application by Member State and by Commission. Member State Users see all their own Documents and the sent Commission Documents. Commission Users see all their own Documents, unsent Integral Member State Documents and sent Member State Documents.</p> <p>Only unsent documents can be deleted. Once a document has been sent to the Commission it cannot be deleted.</p>
-------------	--

The following documents will be foreseen:

Description	Internal Code	Non-Integral (1)	Integral (2)	System (3)	Required (4)
Other Member State Document	PAP.OM	X			
Snapshot of data before send	SNP.PAPSNT		X	X	X
MS Request to withdraw Payment Application version	PAP.WIR	X			



- (1) Document can be sent at any time
- (2) Document will be automatically sent when the Object is sent
- (3) Document automatically created by the system
- (4) Document required in the system before a next action can be executed

Uploading & Sending Documents

NOTE	<p>Only unsent documents can be deleted. Once a document has been sent to the Commission it cannot be deleted.</p>
-------------	---

Multiple documents can be uploaded in the Payment Application.

- Clicking on the **ADD** button  will open a pop-up window allowing you to add a new document type with attachments.

- Selecting a document row and clicking on the **VIEW** icon  will allow you to view the document information.
- Selecting a document row and clicking on the **EDIT** icon  will allow you to modify the document information. If a document of type 'Other Member State Document' must be sent, you can select the edit icon in order to send the document.
- Selecting a document row and clicking on the **DELETE** icon  will allow you to delete the document and all attachments.

REMARK	<p>Integral Documents (Official Proposal etc) are only sent - together with the encoded data – once the Payment Application is sent to the EC.</p> <p>Referential/non-integral Documents (ie. 'Other Member State Document') can be sent at any time independently of the status of the Payment Application.</p> <p>The 'Other Member State Document' type demands a manual submission (they are NOT sent automatically when the object is sent to the EC).</p> <p>A non-integral document is only visible to the Commission when the SENT DATE is visible.</p>
---------------	--

1. Click on the **ADD** button to add a new document:

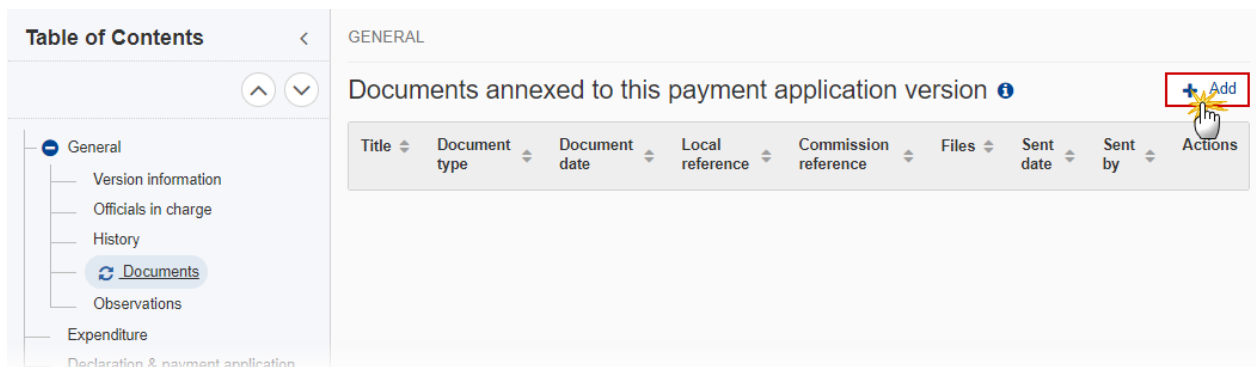

The screenshot shows a user interface for managing documents. On the left is a 'Table of Contents' with a tree view where 'Documents' is selected. The main content area is titled 'GENERAL' and 'Documents annexed to this payment application version'. It features a table with the following columns: Title, Document type, Document date, Local reference, Commission reference, Files, Sent date, Sent by, and Actions. An 'Add' button with a plus icon is located in the top right corner of the table area.

The Edit document details pop-up window appears:

Document

Document title *

Document type *

Document date *

Local reference

ATTACHED FILES



Title	Type	Language	File / Upload	Action
-------	------	----------	---------------	--------

2. Enter or select the following information:

(1) Enter a *Document Title* for your Document.

(2) Select a *Document Type*.

(3) Enter a *Document Date*.

The system automatically fills the field with today's date, but this can be modified.

(4) Enter a *Local reference*.

(5) Click on the **ADD** button to add a new attachment:

- You can add multiple attachments by clicking on the **ADD** button.
- You can remove unwanted attachments by selecting the attachment and clicking on the **REMOVE** button.

The **Attached files** window becomes editable:

ATTACHED FILES

+ Add

Title	Type	Language	File / Upload	Action
Integral doc	Main	English	Browse Choose file	 



3. Enter or select the following information:

(1) Enter a *Title* for your attachment.

(2) Select the *Type* of the document.

It is possible to select from these 4 types: Annex, Cover Letter, Main or Translation.

(3) Select the *Language* of the document.

(4) Click on **BROWSE** to select the file that you want to add as an attachment.

(5) After the attachments are uploaded click on **SAVE**.

REMARK	Integral document types will only display the SAVE button and will be sent when the Payment Application is sent to the Commission. Non-integral document types (such as 'Other Member State Documents') will display the SAVE button and a SAVE & SEND button, and must be sent independently of the Payment Application.
---------------	--

Sending an unsent non-integral document

NOTE	Only unsent documents can be deleted. Once a document has been sent to the Commission it cannot be deleted.
-------------	--

1. Once the document and attachment(s) have been uploaded click on the **EDIT** icon in the row containing the unsent document:

The screenshot shows a 'Table of Contents' interface with a search bar and a navigation menu on the left. The main content area is titled 'GENERAL' and 'Documents annexed to this payment application version'. Below this is a table with the following columns: Title, Document type, Document date, Local reference, Commission reference, Files, Sent date, Sent by, and Actions. A row is highlighted in red, containing the following data: Title: PAP doc, Document type: Other Member State document, Document date: 20/06/2022, Files: 1. The Actions column for this row contains three icons: a pencil (edit), an eye (visibility), and a trash can (delete). A red box highlights the pencil icon, and a mouse cursor is shown clicking on it.

2. Click on **SAVE & SEND** to send the document to the Commission:

ATTACHED FILES

+ Add

Title	Type	Language	File / Upload	Action
PAP	Main	en. English	PAP doc.pdf	 

Cancel

Save

Save & Send 

REMARK

The **SAVE & SEND** button will only be shown for documents which are not integral part of the Object and after at least one attachment was added.

Deletion of an unsent document

NOTE





Only unsent documents can be deleted. Once a document has been sent to the Commission it cannot be deleted.

1. In the row of a previously uploaded unsent document click on the **DELETE** icon to delete the document and associated attachments:

Table of Contents

GENERAL

Documents annexed to this payment application version  + Add

Title	Document type	Document date	Local reference	Commission reference	Files	Sent date	Sent by	Actions
PAP doc	Other Member State document	20/06/2022			1			   

A confirmation window appears:

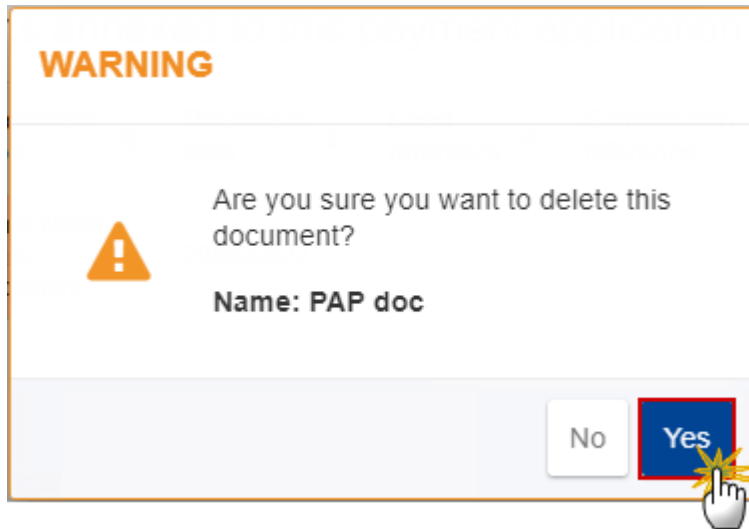

2. Click on **Yes** to confirm deletion. Click on **No** to return to the document section.

Observations

NOTE	<p>This section is used to provide any relevant information to the Payment Application. It can be used as a type of 'chat' between the Member State and Commission.</p> <p>All Users who have Read permission on the Payment Application will be able to read all Observations in the conversation.</p> <p>All Users who have Update permission on the Payment Application will be able to send an observation and participate in the conversation.</p> <p>All observations are kept against the specific version of the Payment Application.</p> <p>The observation is added below the Observations box and includes the username, the date and time of the post.</p>
-------------	--

1. Click on the **ADD** button to add an observation:

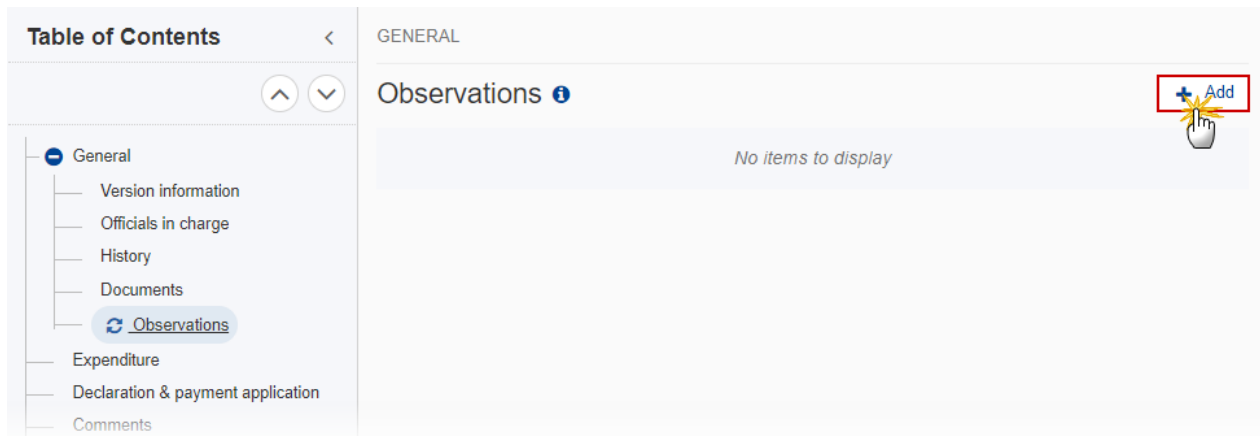

The Add new observation screen appears:

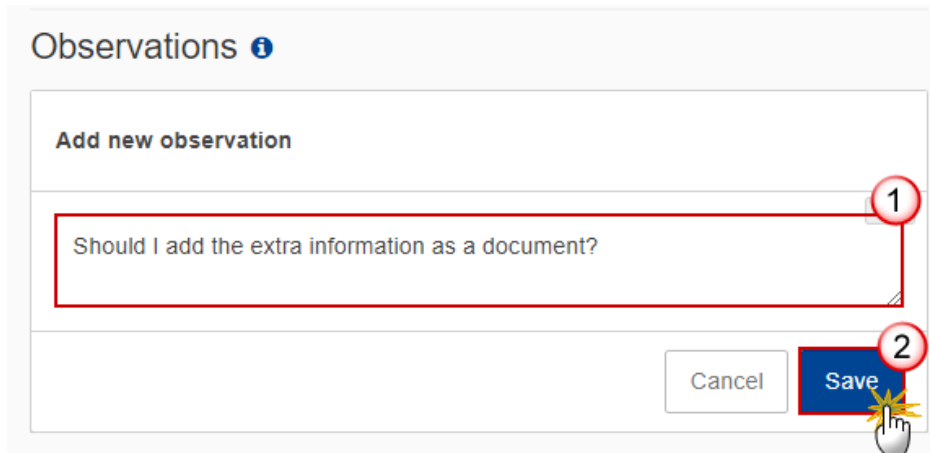

2. Enter the following:

- (1) Enter an observation.
- (2) Click on **ADD** to save the information.

Expenditure

NOTE	A record is automatically foreseen by the create action for each record in table 6 of the linked Programme version. Extra information from the Programme record (Co-financing rate) will be visible in the page to differentiate identical records but with a different co-financing rate.
-------------	--

1. Click on the **EDIT** button to enter the values for the Total amount of Eligible Expenditure and Total amount of Public Expenditure:

Table of Contents

Search: Type to filter TOC

- General
 - Version information
 - Officials in charge
 - History
 - Documents
 - Observations
 - Expenditure**
 - Declaration & payment application
 - Comments
 - Bank information
 - Appendix 1
 - Appendix 3
 - Appendix 4

Expenditure broken down by specific objective as entered into the accounts of the managing authority

This table shall not include expenditure linked to specific objectives for which enabling conditions are not fulfilled, with the exception of operations that contribute to the fulfilment of enabling conditions

Specific objective	Type of action	Calculation basis (A)	Co-financing rate	Total amount of eligible expenditure (B)	Total amount of Union contribution (C)
1. CEAS	Regular actions	Total	100.0000000000 0%		
	Annex IV actions	Total	0.0000000000%		
2. Legal migration and integration	Regular actions	Total	100.0000000000 0%		
	Annex IV actions	Total	0.0000000000%		
3. Return	Regular actions	Total	100.0000000000 0%		
	Annex IV actions	Total	0.0000000000%		
4. Solidarity	Regular actions	Total	100.0000000000 0%		



The Edit details pop-up window appears:

Expenditure broken down by specific objective as entered into the accounts of the managing authority

This table shall not include expenditure linked to specific objectives for which enabling conditions are not fulfilled, with the exception of operations that contribute to the fulfilment of enabling conditions

Specific objective	Type of action	Calculation basis (A)	Co-financing rate	Total amount of eligible expenditure (B)	Total amount of Union contribution (C)	Total amount of public contribution made or to be made (D)
1. CEAS	Regular actions	Total	100.0000000000 0%			
	Annex IV actions	Total	0.0000000000%			
2. Legal migration and integration	Regular actions	Total	100.0000000000 0%			
	Annex IV actions	Total	0.0000000000%			
3. Return	Regular actions	Total	100.0000000000 0%			
	Annex IV actions	Total	0.0000000000%			
4. Solidarity	Regular actions	Total	100.0000000000 0%			
Grand total						

1

2

2. Enter the following:

- (1) Enter the amounts in the columns.
- (2) Click on **SAVE** to save the information.

REMARK	<p>The TA 36(5) Total amount of Union contribution (C) is calculated and is equal to the SUM [(B+C) when A in (Total,null) or D when A is Public] * Co-financing rate * 6%.</p> <p>Example:</p>							
	Specific Objective	Type of Action	Co-Financing Rate	Calculation basis	B	C	D	TA36(5) = Co-Financing Rate * (B+C) or D * 6%
	SO1	Regular actions	50%	T	100 €	100€	180 €	6.00 €
	SO1	Operating Support	60%	P	100 €	100€	200 €	7.20 €
	TA 36(5)				13.20 €			13.20 €

Declaration & payment application

NOTE	<p>The requester type comes from the linked Programme version Authority information. When there is an “Accounting function in case this function is entrusted to a body other than the managing authority” in the Programme, then we use this requester type, else we use the “Managing authority” requester type.</p> <p>The requested amounts are not updateable and will be automatically filled in, based on the declaration of expenditure and the amounts already paid for this Accounting Year (calculated by the Commission SFC2021 Back-Office service). No manual encoding of the requested amounts will be allowed, even when the SFC2021 Back-Office service is temporary not available. If the Member State has questions about the calculations they can contact their Desk officer for more information.</p>
-------------	---

- 1. Click on the **EDIT** button to edit information in the table:

Table of Contents < **DECLARATION** ⓘ Edit

By validating this payment application the managing authority requests the payment of the amounts as mentioned below.

Representing the managing authority responsible for the accounting function:

Gsb, Ste

Fund	Amount
AMIF	

No validation result available

The Edit details pop-up window appears:

DECLARATION ⓘ

By validating this payment application the managing authority requests the payment of the amounts as mentioned below.

Representing the managing authority responsible for the accounting function: *

Gsb, Ste

Fund	Amount
AMIF	

Cancel Save

2. Enter the following:

(1) Enter the name of the person *Representing the managing authority responsible for the accounting function*.

The "Representing the ..." in the Declaration is automatically filled in with the first name and last name of the User who initially created the Payment Application version but can be manually updated.

(2) Click on **SAVE** to save the information.

Comments

1. Click on the **EDIT** button to add comments:

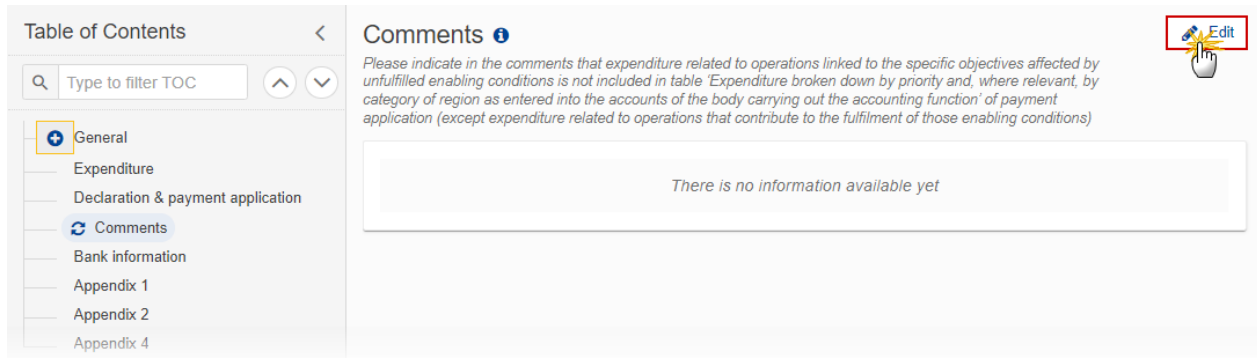

The Edit details pop-up window appears:

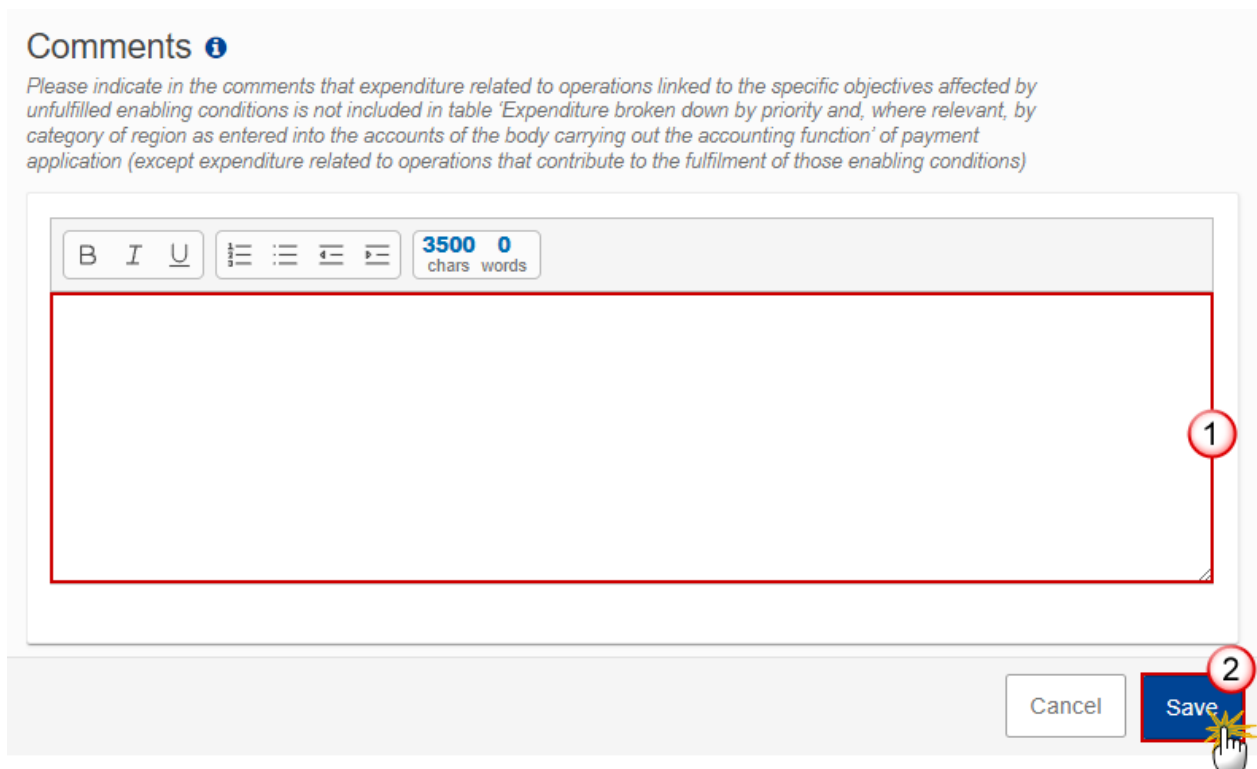

2. Enter the following:
 - (1) Enter the *Comments*.
 - (2) Click on **SAVE** to save the information.

Bank information

NOTE	The "Bank Account" information is automatically pre-filled with data received from a Back-office web service. This Bank Account information should exist in the Back-Office against the Commitments for this CCI and Fund. If this Back-Office service is not available or doesn't return anything, get the information from a previous Payment Application version for the same Fund. Only 1 bank account has to be defined.
-------------	---

1. Click on the **EDIT** button to edit the Bank account information:

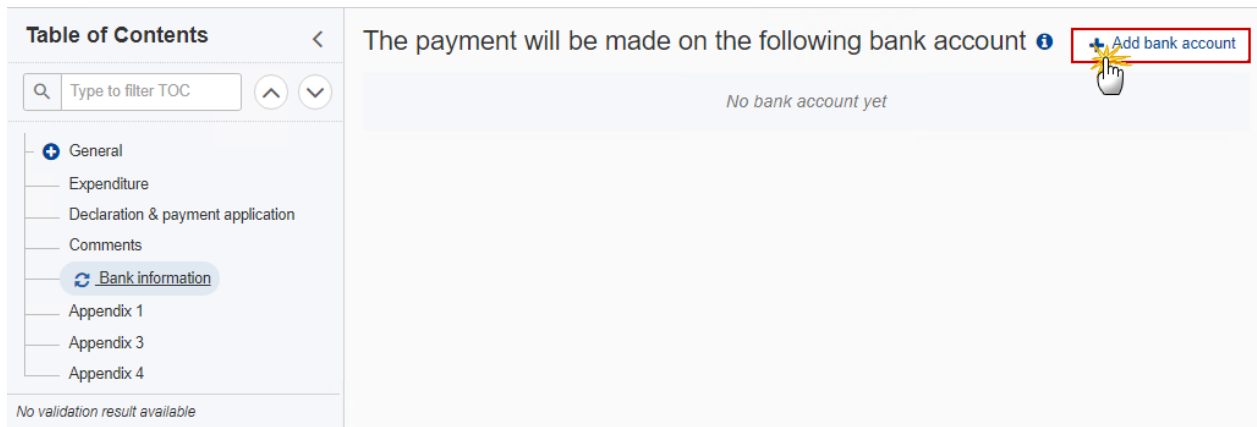

The screenshot shows a web application interface. On the left, there is a 'Table of Contents' sidebar with a search bar and a list of sections: General, Expenditure, Declaration & payment application, Comments, Bank information (highlighted), Appendix 1, Appendix 3, and Appendix 4. The main content area has a header that reads 'The payment will be made on the following bank account' with an information icon. Below this, there is a red-bordered button labeled 'Add bank account' with a mouse cursor pointing at it. The text 'No bank account yet' is displayed below the button. At the bottom left of the sidebar, it says 'No validation result available'.

The Edit details pop-up window appears:

The payment will be made on the following bank account 

Body identified * 1

Bank * 2

BIC * 3

Bank account IBAN * 4

Holder of account (where not the same as body identified) 5

6

Cancel Save 

2. Enter the following:

- (1) Enter the *Body identified*.
- (2) Enter the *Bank* name.
- (3) Enter the *BIC* number.
- (4) Enter the *Bank account IBAN* number.
- (5) Enter the *Holder of account (where not the same as the body identified)*.
- (6) Click on **SAVE** to save the information.

Appendix 1

NOTE	A record is automatically foreseen by the create action for each distinct Specific Objective, Type of Action, non-technical assistance record in table 6 of the linked Programme version.
-------------	---

1. Click on the **EDIT** button to add the information:

Table of Contents <

Q Type to filter TOC

- General
- Expenditure
- Declaration & payment application
- Comments
- Bank information
- Appendix 1
- Appendix 3
- Appendix 4

Appendix 1 ⓘ

Information on programme contributions paid to financial instruments as referred to in Article 92 and included in the payment applications (cumulative from the start of the programme)

Edit

Specific objective	Type of action	Amount included in the first payment application and paid to the financial instrument ⓘ		Corresponding cleared amount as referred to in Article 92(3)	
		Total amount of programme contributions paid to financial instruments (A)	Total amount of corresponding public contribution (B)	Total amount of programme contributions pursuant to Article 92(2)(b) (C)	Total amount of corresponding public contribution (D)
1. CEAS	Regular actions				
1. CEAS	Annex IV actions				
2. Legal migration and integration	Regular actions				
2. Legal migration and integration	Annex IV actions				
3. Return	Regular actions				
3. Return	Annex IV actions				
4. Solidarity	Regular actions				

The Edit details pop-up window appears:

Appendix 1 ⓘ

Information on programme contributions paid to financial instruments as referred to in Article 92 and included in the payment applications (cumulative from the start of the programme)

Specific objective	Type of action	Amount included in the first payment application and paid to the financial instrument ⓘ		Corresponding cleared amount as referred to in Article 92(3)	
		Total amount of programme contributions paid to financial instruments (A)	Total amount of corresponding public contribution (B)	Total amount of programme contributions pursuant to Article 92(2)(b) (C)	Total amount of corresponding public contribution (D)
1. CEAS	Regular actions				
1. CEAS	Annex IV actions				
2. Legal migration and integration	Regular actions				
2. Legal migration and integration	Annex IV actions				
3. Return	Regular actions				
3. Return	Annex IV actions				
4. Solidarity	Regular actions				
Grand total					

Cancel
Save

2. Enter the following:

- (1) Enter the amounts in the columns.
- (2) Click on **SAVE** to save the information.

Appendix 3

NOTE	A record is automatically foreseen by the create action for each distinct Specific Objective, Type of Action record in table 6 of the linked Programme version.
-------------	---

1. Click on the **EDIT** button to add the information:

Table of Contents <

Q Type to filter TOC ^ v

- General
- Expenditure
- Declaration & payment application
- Comments
- Bank information
- Appendix 1
- Appendix 3**
- Appendix 4

No validation result available

Appendix 3 ⓘ

Information on expenditure linked to specific objectives for which enabling conditions are not fulfilled, with the exception of operations that contribute to the fulfilment of enabling conditions (cumulative from the beginning of the programming period)





Specific objective	Type of action	Calculation basis (A)	Eligible expenditure or Union contribution linked to non-fulfilled enabling conditions ⓘ		Eligible expenditure or Union contribution linked to fulfilled enabling conditions ⓘ	
			Total (B)	Public (C)	Total (D)	Public (E)
1. CEAS	Regular actions	Total				
1. CEAS	Annex IV actions	Total				
2. Legal migration and integration	Regular actions	Total				
2. Legal migration and integration	Annex IV actions	Total				
3. Return	Regular actions	Total				
3. Return	Annex IV actions	Total				
4. Solidarity	Regular actions	Total				
Grand total						

The Edit details pop-up window appears:

Appendix 3

Information on expenditure linked to specific objectives for which enabling conditions are not fulfilled, with the exception of operations that contribute to the fulfilment of enabling conditions (cumulative from the beginning of the programming period)

Specific objective	Type of action	Calculation basis (A)	Eligible expenditure or Union contribution linked to non-fulfilled enabling conditions 		Eligible expenditure or Union contribution linked to fulfilled enabling conditions 	
			Total (B)	Public (C)	Total (D)	Public (E)
1. CEAS	Regular actions	Total				
1. CEAS	Annex IV actions	Total				
2. Legal migration and integration	Regular actions	Total				
2. Legal migration and integration	Annex IV actions	Total				
3. Return	Regular actions	Total				
3. Return	Annex IV actions	Total				
4. Solidarity	Regular actions	Total				
Grand total						

2. Enter the following:

(1) Enter the amounts in the columns.

Column D is the sum of columns B and C from the expenditure table of the last accepted Payment Application version of each past Accounting Year, plus from the current Payment Application version. Column E is the sum of columns D and C from the expenditure table of the last accepted Payment Application version of each past Accounting Year, plus from the current Payment Application version.

Columns B and C for Technical Assistance records (TA.36(5) and TA.37) are not editable.

(2) Click on **SAVE** to save the information.

Appendix 4

NOTE	A record is automatically foreseen by the create action for each distinct Specific Objective, Type of Action, non-Technical Assistance record in table 6 of the linked Programme version.
-------------	---

1. Click on the **EDIT** button to add the information:

Table of Contents < Appendix 4 ⓘ

Advances paid in the context of State aid (Article 91(5)) and included in the payment applications (cumulative from the start of the programme)

^ v

- General
- Expenditure
- Declaration & payment application
- Comments
- Bank information
- Appendix 1
- Appendix 3
- Appendix 4**

No validation result available

Specific objective	Type of action	Total amount paid as advances (A)	Amount which has been covered by expenditure paid within three years ⓘ (B)	Amount which has not been covered by expenditure paid ⓘ (C)
1. CEAS	Regular actions			
1. CEAS	Annex IV actions			
2. Legal migration and integration	Regular actions			
2. Legal migration and integration	Annex IV actions			
3. Return	Regular actions			
3. Return	Annex IV actions			
4. Solidarity	Regular actions			
Grand total				

[Edit](#)

The Edit details pop-up window appears:

Appendix 4 ⓘ

Advances paid in the context of State aid (Article 91(5)) and included in the payment applications (cumulative from the start of the programme)

Specific objective	Type of action	Total amount paid as advances (A)	Amount which has been covered by expenditure paid within three years ⓘ (B)	Amount which has not been covered by expenditure paid ⓘ (C)
1. CEAS	Regular actions			
1. CEAS	Annex IV actions			
2. Legal migration and integration	Regular actions			
2. Legal migration and integration	Annex IV actions			
3. Return	Regular actions			
3. Return	Annex IV actions			
4. Solidarity	Regular actions			
4. Solidarity	Annex IV actions			
Grand total				

2. Enter the following:

- (1) Enter the amounts in the columns.
- (2) Click on **SAVE** to save the information.

Validate the Payment Application (AMIF, ISF, BMVI)

REMARK	<p>The Payment Application can be validated at any time, when the current version is in status OPEN and resides at the User's Node.</p> <p>To validate the Payment Application, the User must have the role of MS Managing Authority or Body entrusted with the accounting function with Update or Send rights (MSMAu/s or MSAFu/s).</p>
---------------	--

Click on the **VALIDATE** button to validate the Payment Application:

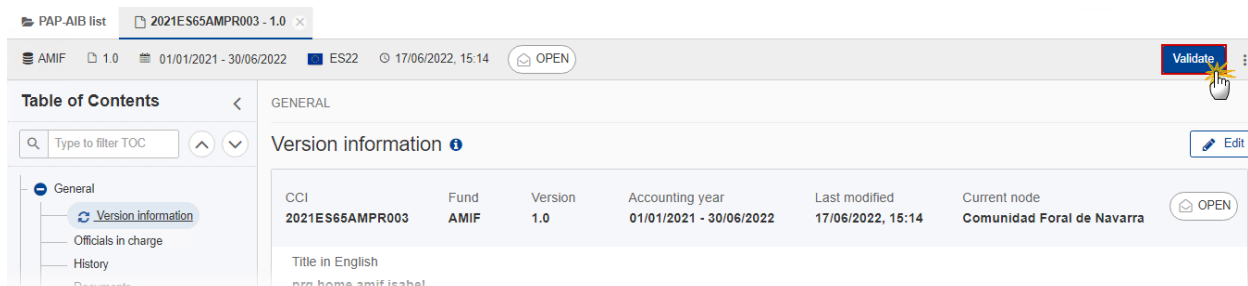

REMARK	<p>An ERROR will block you from sending the Payment Application. The error(s) should be resolved and the Payment Application must be revalidated. Note that a WARNING does not block you from sending the Payment Application.</p>
---------------	--

The system validates the following information:

Code	Severity	Validation Rule
001	WARNING	Validate that at least one official in charge of the Member State exists.
002	ERROR	Validate that the CCI code matches the following regular expression: For AMIF, ISF and BMVI (.....65AMPR... 65ISPR... 65BVPR...) (Implicit in web).
003	ERROR	Validate that the programme is already adopted (Implicit in web).
004	ERROR	Validate that the start date of eligibility of the linked programme version is smaller or equal to the end date of the accounting year of this payment application and that the end date of eligibility is greater or equal to the start date of the accounting year.

005	ERROR	Validate that the payment application is for a Fund covered by the programme (Implicit in web).
006	ERROR	Validate that the records in the expenditure table are equivalent (not less, not more) to the following information in the linked programme version (Implicit in web): Table 6 for AMIF/ISF/BMVI programmes.
010	ERROR	Validate for AMIF, ISF and BMVI programmes in the expenditure table, that the absolute amount of column 'Total amount of eligible expenditure incurred by beneficiaries and paid in implementing operations in accordance with point (a) of Article 91(3) and point (c) of Article 91(4)' is \geq the absolute amount of column 'Total amount of public contribution made or to be made in accordance with point (c) of Article 91(3)' and that the amounts in these two columns have the same sign.
011	ERROR	Validate that the records in the application for payment table are equivalent (not less, not more) to the following information in the linked programme version (Implicit in web): Distinct Fund records from table 6 for AMIF/ISF/BMVI programmes.
012	ERROR	Validate when the PAP setting "pap.<fund>.allow.negative.claim" for the Fund of the Payment Application is false, that the total requested amount in the payment application is ≥ 0 .
013	WARNING	Validate that the IBAN format is correct.
014	ERROR	Validate that the "Body identified", the "Bank", the "BIC" and the "Bank account IBAN" are provided (Implicit in web).
015	ERROR	Validate that the records in appendix 1 are equivalent (not less, not more) to the following information in the linked programme version (Implicit in web): Distinct specific objective, action type records from table 6 for AMIF/ISF/BMVI programmes, TA excluded.
019	ERROR	Validate for AMIF, ISF and BMVI programmes per record in appendix 1 that the amount in column 'Total amount of corresponding public contribution' (B) is \leq the amount in column 'Total amount of programme contributions paid to financial instruments' (A).
023	ERROR	Validate for AMIF, ISF and BMVI programmes per record in appendix 1 that the amount in column 'Total amount of corresponding public expenditure'

		(D) is <= the amount in column 'Total amount of programme contributions pursuant to Article 92(2)(b)' (C).
027	WARNING	Validate for AMIF, ISF and BMVI programmes per record in appendix 1 that the amount in column 'Total amount of programme contributions pursuant to Article 92(2)(b)' (C) is <= the amount in column 'Total amount of programme contributions paid to financial instruments' (A).
031	WARNING	Validate for AMIF, ISF and BMVI programmes per record in appendix 1 that the amount in column 'Total amount of corresponding public contribution' (D) is <= the amount in column 'Total amount of corresponding public contribution' (B).
035	ERROR	Validate per record in appendix 1 that the amount per specific objective and action type for AMIF, ISF and BMVI in column A and B is <= the sum of the amounts under the respective specific objective and action type for AMIF, ISF and BMVI in the expenditure table of the payment applications including the earlier accounting years of columns (B)+(C) and (D) (take last version of each accounting year). In other words, the basic principle is that expenditure related to financial instruments cannot exceed the total expenditure in the respective records.
037	ERROR	Validate that the records in appendix 3 are equivalent (not less, not more) to the following information in the linked programme version (Implicit in web): Distinct specific objective, action type records from table 6 for AMIF/ISF/BMVI programmes, TA excluded.
038	ERROR	Validate that the records in appendix 4 are equivalent (not less, not more) to the following information in the linked Programme version (Implicit in web): Distinct specific objective, action type records from table 6 for AMIF/ISF/BMVI programmes, TA excluded.
042	WARNING	Validate for AMIF, ISF and BMVI programmes per record in appendix 4 that the 'Total amount paid as advances' (A) = 'Amount which has been covered by expenditure paid by beneficiaries within three years of the payment of the advance' (B) + 'Amount which has not been covered by expenditure paid by beneficiaries and for which the three-year period has not yet elapsed' (C).
043	ERROR	Validate that all integral documents have at least one attachment with a length > 0.
044	ERROR	Validate that at least one bank account record is provided.

045	ERROR	Validate when first working version, that the end date for submission for the Accounting Year (AccountingYear.submitToDate) has not been passed.
046	ERROR	Validate for AMIF, ISF and BMVI that only 1 bank account has been defined.

An example of a validation window:

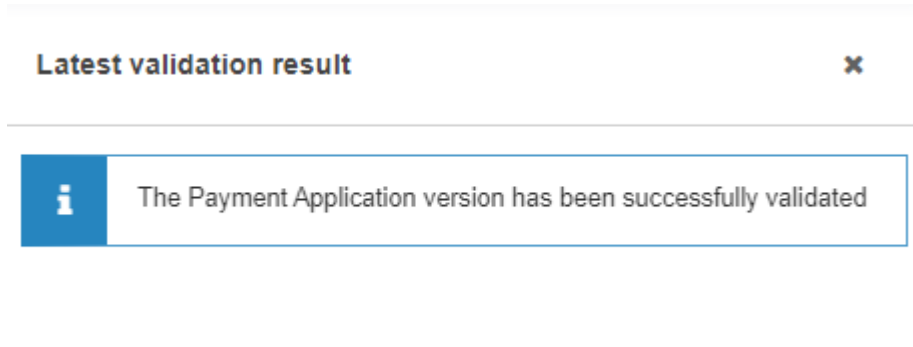

You can check the list of validation results at any time throughout the Payment Application:

Table of Contents

- General
 - Version information
 - Officials in charge
 - History
 - Documents
 - Observations
- Expenditure
- Declaration & payment application
- Comments
- Bank information
- Appendix 1
- Appendix 2
- Appendix 4

Version information

CCI
2021ES65AMPR003

Title in English
Prg ijg erdf+esf test

Commission decision
C(2022)1982

Eligible from
01/01/2021

National reference

Latest validation result

- PAP_001**
Validate that at least one official in charge of the Member State exists.
- PAP_002**
Validate that the CCI code matches the following regular expression: • For IJG (.....16..PR...]......16..TA...]......05..PR...]......05..TA...)] • For ETC (.....TC16.....) • For EMFAF (.....14MFPR...) • For AMIF, ISF and BMVI (.....65AMPR...]......65ISPR...]......65BVPR...)] (Implicit in web).
- PAP_003**
Validate that the programme is already adopted (Implicit in web).
- PAP_004**
Validate that the start date of eligibility of the linked programme version is smaller or equal to the end date of the accounting year of this payment

45 All results 44 Passed 1 Warning 0 Error

To see the last validation results:

- (1) Click on one of the 4 categories: *All results, Passed, Warning, Error*.
- (2) The list of latest validation results for the chosen category is displayed.

After all errors have been resolved the status of the Payment Application becomes **VALIDATED**.

Prepare Payment Application (AMIF, ISF, BMVI) for send to EC

REMARK	<p>The Prepare for Send can occur when a User on the highest MS Node wants to indicate that the Payment Application version can be prepared for sending to the Commission, once the VALIDATION ERRORS have been removed and the status is VALIDATED.</p> <p>To prepare the send of the Payment Application, the User must have the role of MS Managing Authority or Body entrusted with the accounting function with Update or Send rights (MSMAu/s or MSFAu/s) for the funds managed by the Programme.</p>
---------------	--

1. Click on the **PREPARE FOR SEND TO EC** button to prepare to send the Payment Application to the Commission:

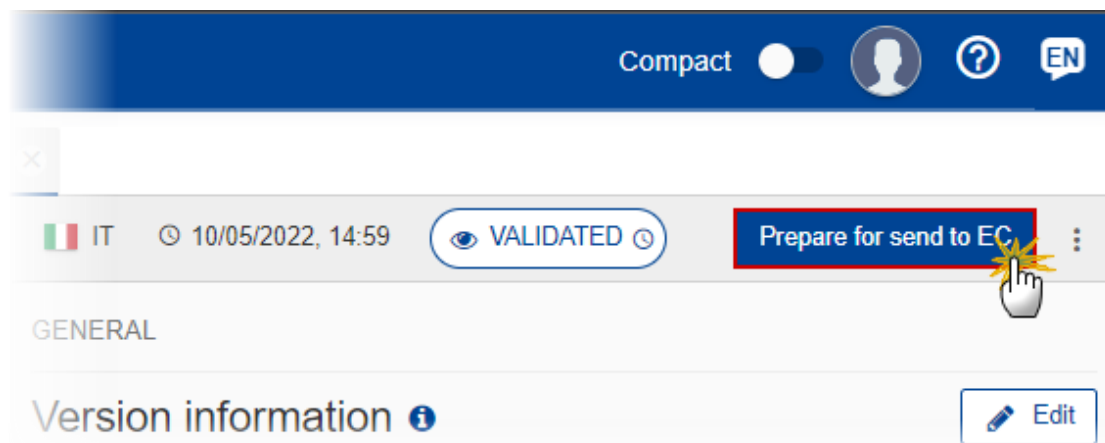

The system will ask you to confirm the send action:

Prepare payment application for send to EC						
This action will generate a snapshot document in a couple of minutes. After this has been done you will be able to send this object to the commission						
CCI	Fund	Version	Accounting year	Last modified	Current node	VALIDATED
2021ES65AMPR003	AMIF	1.0	01/01/2021 - 30/06/2022	05/05/2022, 11:54	Comunidad Foral de Navarra	

- Click on **CONFIRM** to confirm.

The status of the Payment Application is set to **PREPARING FOR SEND TO EC**.

REMARK	When on the highest MS node, a 'Snapshot' document will be available in all official MS languages in the DOCUMENTS section so that the sender can first verify what will be sent to the Commission.
---------------	--

Send the Payment Application (AMIF, ISF, BMVI)

REMARK	<p>The Payment Application can only be sent once the VALIDATION ERRORS have been removed and the status is READY TO SEND.</p> <p>The "4 eyes principle" must be respected. Therefore, the User sending must be different from the User who last validated.</p> <p>To send the Payment Application, the User must have the role of MS Managing Authority or Body entrusted with the accounting function with Send rights (MSMAs/MSFAs) for all the concerned funds.</p>
---------------	---

- Click on the **SEND** button to send the Payment Application to the Commission or to the upper Node:

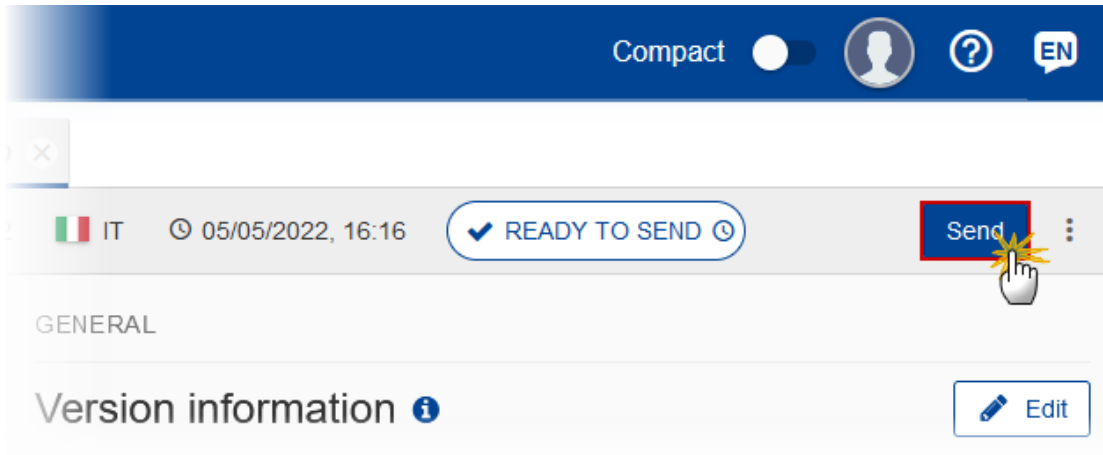

The system will ask you to confirm the send action:

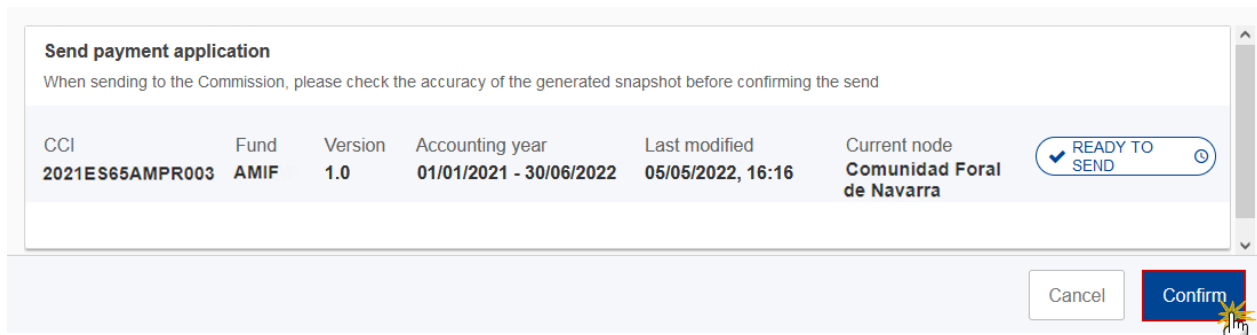

2. Click on **CONFIRM** to confirm.

On success, the Payment Application version has been sent to the Commission or to the upper Node. When sent, the status is set to **SENT**.

<p>REMARK</p>	<p>When the requested amounts are recalculated by the SFC2021-BO and differ from what was previously persisted, the status of this payment application will be set back to VALIDATED.</p> <p>When on the highest MS node, different versions of the generated “Snapshot before send” document will be available so that the sender can first verify what will be sent to the Commission:</p> <ul style="list-style-type: none"> • A version containing the untranslated content with the template in the Source language. • When the Source language is different from English, a version containing the untranslated content with the template in English. • When the Source language is different from English, a version containing a machine translation of the content in English with the template in English. <p>The requested amounts in the Application for Payment are automatically calculated and persisted by the SFC2021 Back Office (SFC2021-BO) calculation service, each time a modification is done on the Expenditure table. This applies for all Funds and types. Since, between the last update of the Expenditure table and the sending of the Payment Application to the Commission, there could be changes in the already paid amounts for this Accounting Year, we need to recalculate and to persist them just before sending to the Commission. If the calculated requested amounts differ from what was previously persisted, a message on the send confirmation page will say “Please note the requested amounts were recalculated and are different than previously presented on the page and in the snapshot document. The status of this payment application will be set back to ‘Validated’. You will need to re-execute the ‘Prepare for send to EC’ generating an updated snapshot document, and then re-execute the ‘Send’”.</p> <p>When the SFC2021-BO calculation service is down or errors, a message on the send confirmation page will say "Application for payment cannot be sent since the Back-Office calculation service is temporarily not available. Please try again later".</p>
----------------------	--

Request for Revised Payment Application (AMIF, ISF, BMVI) by MS

REMARK	<p>The Payment Application can only be revised by MS when a lower Node exists and the status is SENT (to a higher MS node), OPEN, VALIDATED, READY TO SEND or REVISION REQUESTED BY MS.</p> <p>This action can be used when a User wants to request a revision for the Payment Application version sent by the Member State/Region because it is incomplete or incorrect.</p> <p>To request a revised Payment Application version, the User must have the role of MS Managing Authority or Body entrusted with the accounting function with Update rights (MSMAu/MSAFu).</p>
---------------	--

Follow the steps to request for revised Payment Application by MS:

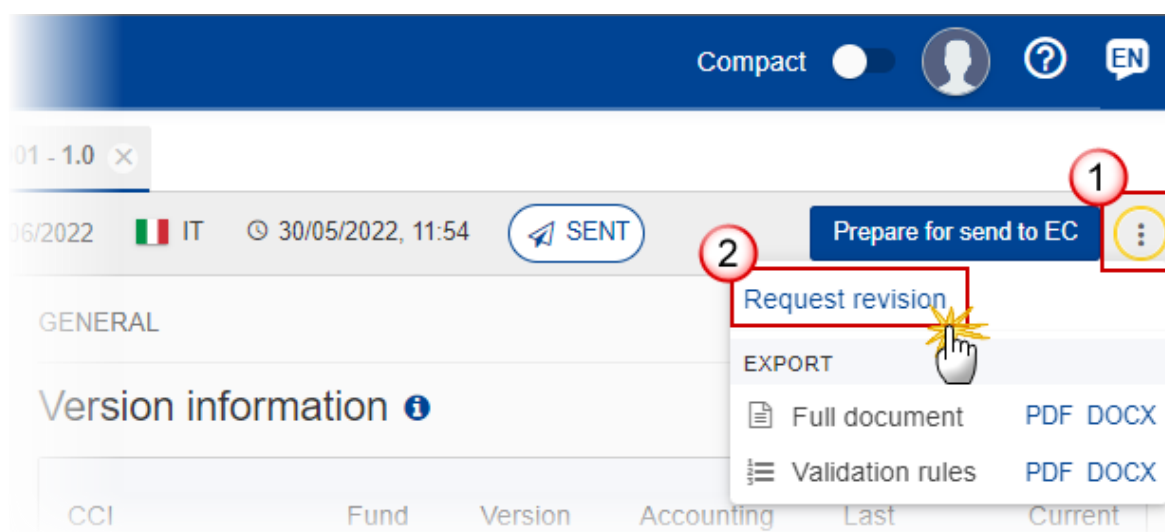

1. Select the following:

- (1) Select the icon with 3 vertical dots.
- (2) Click on the **REQUEST REVISION** button to request revision from the lower Node.

The system will ask you to confirm the request for revision:

Request for revision of payment application

CCI	Fund	Version	Accounting year	Last modified	Current node	
2021ES65AMPR003	AMIF	1.0	01/01/2021 - 30/06/2022	30/05/2022, 11:54	Comunidad Foral de Navarra	

Reason for request for revision *

Reason...

1. Enter the following:

(1) Enter the *Reason* in the text box provided.

(2) Click on **CONFIRM** to save the information.

On success, the status of the Programme will be changed to status **REVISION REQUESTED BY MS** and the sender is notified of the action and its reason.

Delete the Payment Application (AMIF, ISF, BMVI)

REMARK	<p>The Payment Application can only be deleted when:</p> <ul style="list-style-type: none"> it resides on the owner Node the status is OPEN, VALIDATED or READY TO SEND or REVISION REQUESTED BY MS it has never been sent to the Commission before it has no sent documents attached. <p>To delete the Payment Application, the User must have the role of MS Managing Authority or Body entrusted with the accounting function with Update rights (MSMAu/MSFau).</p> <p>The delete is a physical delete and cannot be recovered!</p>
---------------	---

Follow the steps to remove the Payment Application from the system:

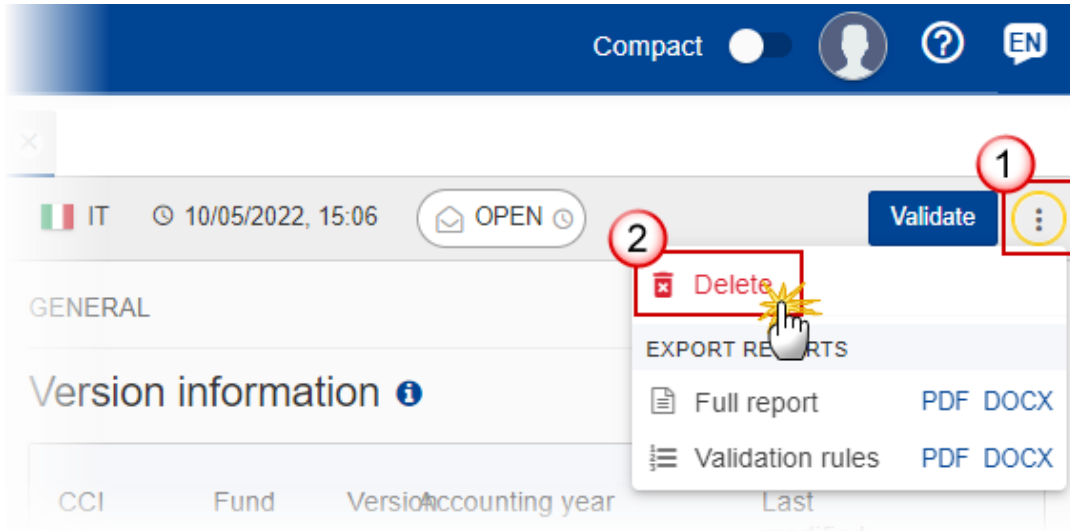

1. Select the following:

(1) Select the icon with 3 vertical dots.

(2) Click on the **DELETE** button to remove the Payment Application from the system.

The system will ask you to confirm the delete action:

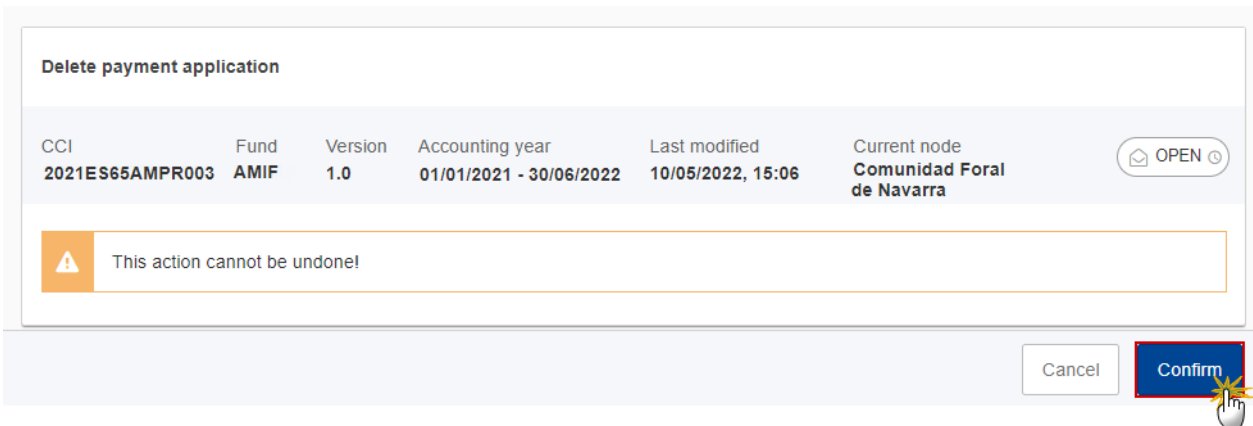

2. Click on **CONFIRM** to confirm or click on **CANCEL** to return to the Payment Application.

Cancel the Payment Application (AMIF, ISF, BMVI)

REMARK	<p>The Payment Application can only be cancelled when a Payment Application version with documents was sent to the Commission and without any previous work version in status REVISION REQUESTED BY EC. The notification utility will be called to notify the Commission of the cancel of the version.</p> <p>The Payment Application version must currently reside on the User's Node and its status is OPEN, VALIDATED, READY TO SEND or REVISION REQUESTED BY MS and contains a sent Document and has no previous working version of the same major version in status REVISION REQUESTED BY EC.</p> <p>To cancel the Payment Application, the User must have the role of MS Managing Authority or Body entrusted with the accounting function with Update rights (MSMAu/MSFAu).</p>
---------------	--

Follow the steps to cancel the Payment Application from the system:

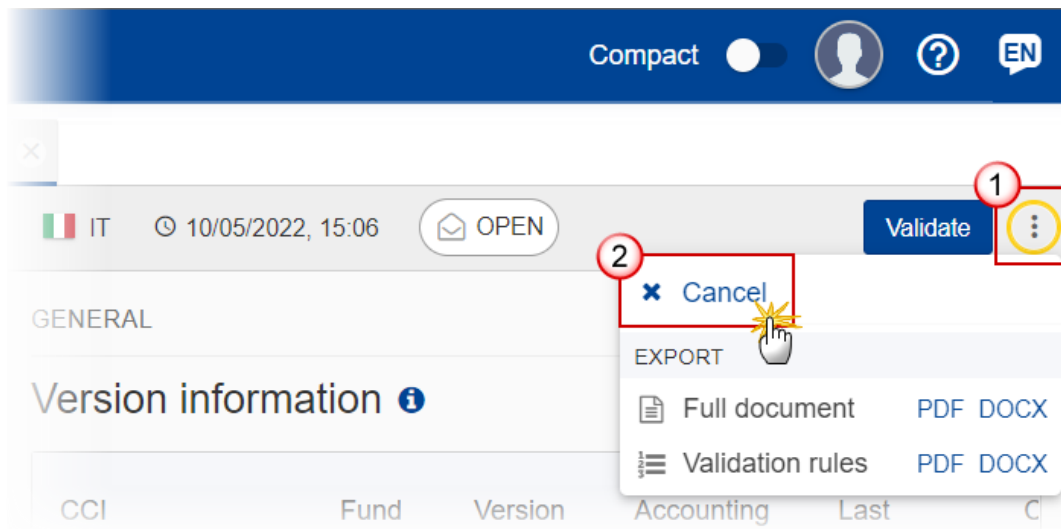

1. Select the following:

- (1) Select the icon with 3 vertical dots.
- (2) Click on the **CANCEL** button to cancel the Payment Application from the system.

The system will ask you to confirm the cancel action:

Cancel payment application						
CCI	Fund	Version	Accounting year	Last modified	Current node	
2021ES65AMPR003	AMIF	1.0	01/01/2021 - 30/06/2022	10/05/2022, 15:06	Comunidad Foral de Navarra	OPEN
						<input type="button" value="Cancel"/> <input type="button" value="Confirm"/>

- Click on **CONFIRM** to confirm or click on **CANCEL** to return to the Payment Application.

On success, the status of the Payment Application will be changed to **CANCELLED**.

Create a New Version of the Payment Application (AMIF, ISF, BMVI)

REMARK	<p>A new version of the Payment Application can only be created when the last version is in status REVISION REQUESTED BY EC</p> <p>To create a new version, the User must have the role of MS Managing Authority or Body entrusted with the accounting function with Update rights (MSMAu/MSFAu).</p>
---------------	--

- Click on the **CREATE** button to create a new version of the Payment Application:

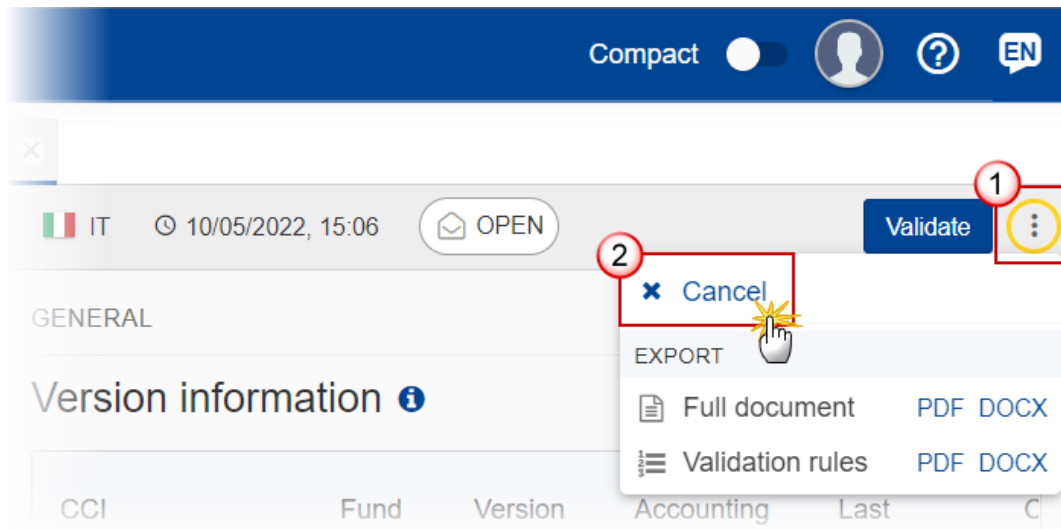

The system will ask you to confirm the creation of a new version:

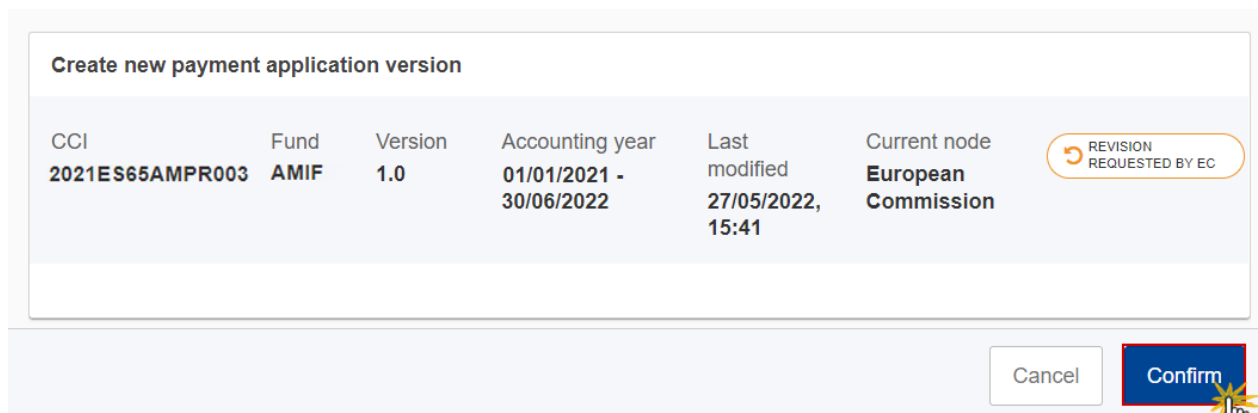

2. Click on **CONFIRM** to confirm. Click on **CANCEL** to return to the Payment Application.

On success, a new version of the Payment Application has been created as a copy of the last version, with a version number identical to the previous and a working version number incremented by one. Its status is set to **OPEN**.

Request to Withdraw the Payment Application (AMIF, ISF, BMVI)

REMARK	<p>The Member State must request to withdraw the Payment Application by uploading a document called MS Request to withdraw Payment Application version.</p> <p>The Payment Application version is in a status SENT, REVISION REQUESTED BY EC at the level of the Commission, or in a status OPEN, VALIDATED, READY TO SEND, REVISION REQUESTED BY MS at the owner Node of the Member State and has previously been sent to the Commission.</p> <p>This scenario occurs when at the request of the Member State the Commission withdraw a Payment Application version and stop the amendment procedure.</p> <p>To request to withdraw the Payment Application, the User must have the role of MS Managing Authority or Body entrusted with the accounting function with Update and Send rights (MSMAu+MSMAs/MSFAu+MSFAs).</p>
---------------	--

1. Go to the **Documents** section and click on the **ADD** button to add the **MS Request to withdraw Payment Application version** document type:

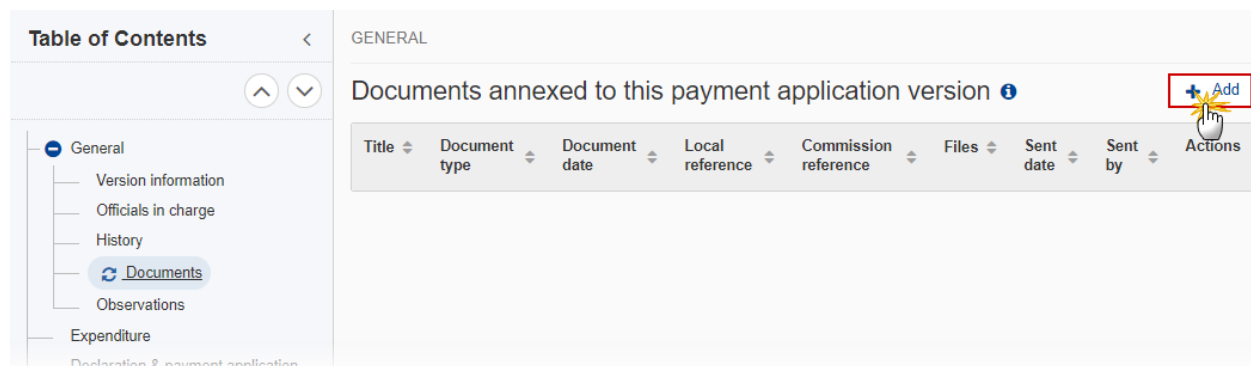

2. The Member State must request to withdraw the Payment Application by selecting the withdraw document and entering the mandatory information:

Document

✕ Document has not yet been sent

Document type * 1 Document date * 2

MS Request to withdraw payment application version 3 27/05/2022 4

Document title * 5 Withdraw request 239

Local reference 6

ATTACHED FILES 7 8 + Add

Title	Type	Language	File / Upload	Action
-------	------	----------	---------------	--------

3. Enter or select the following information:

(1) Select the **MS Request to withdraw Payment Application version** *Document Type*.

(2) Enter a *Document Date*.

The system automatically fills the field with today's date, but this can be modified.

(3) Enter a *Document Title* for your Document.



(4) Enter a *Local reference*.

(5) Click on the **ADD** button to add a new attachment:

- You can add multiple attachments by clicking on the **ADD** button.
- You can remove unwanted attachments by selecting the attachment and clicking on the **REMOVE** button.

The **Attached files** window becomes editable:

ATTACHED FILES + Add

Title	Type	Language	File / Upload	Action
Withdraw PAP version	Main	en. English	Browse File uploaded!	 

4. Enter or select the following information:

(1) Enter a *Title* for your attachment.

(2) Select the *Type* of the document.

It is possible to select from these 4 types: Annex, Cover Letter, Main or Translation

(3) Select the *Language* of the document.

(4) Click on **BROWSE** to select the file that you want to add as an attachment.

(5) After the attachments are uploaded click on **SAVE & SEND** to save and send the document.

REMARK	<p>Withdrawals are subject to confirmation by the Commission. After the document is uploaded, it is up to the Commission User to perform the withdrawal action and stop the amendment procedure. On success, the Payment Application version status will be set to WITHDRAWN AT THE REQUEST OF THE MS.</p>
---------------	---